

How to Prevent Conveyor Belt Mistracking

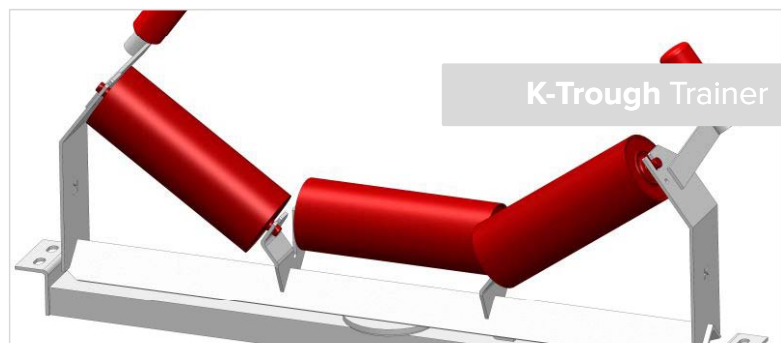
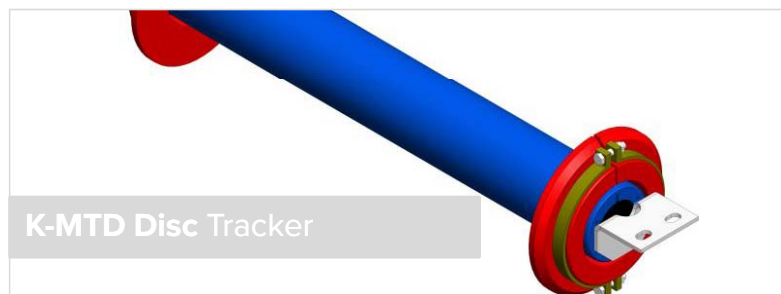

How to Prevent Conveyor Belt Mistracking

Section 1: Rule Zero and Set-Up

1.1

- Identify areas along the conveyor, which are suffering from misalignment.
- Before carrying out any work, be sure to properly tag and/ or lock out the conveyor system. You may also need to adhere to specific site safety requirements.



1.2

- Consider whether you are training a newly installed conveyor belt or attempting to fix an existing issue.

1.3

- If the conveyor belt has only just been installed then start by implementing “Rule Zero”!

RULE ZERO

- All pulleys, snub rollers, carrying idlers and return idlers must be **SQAURE** with the frame and **PARALLEL** with each other.

1.4

- Most conventional trough/flat carry and return idler frames will have slots rather than round holes that allow for tracking adjustment.

Shown in Figure 1.4

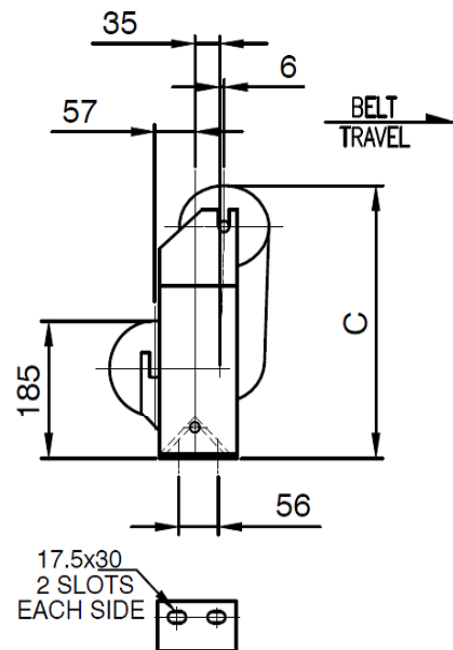
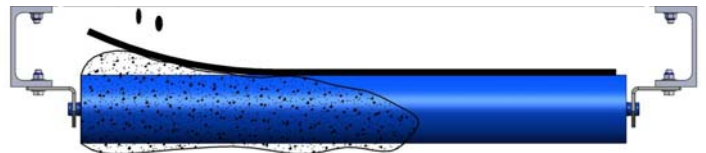

Figure 1.4 (above)

1.5

- Be sure to check all pulleys, tracking idlers, carry rollers and return rollers are free from build up and are rotating freely. Any worn or seized components will cause belt mistracking.



How to Prevent Conveyor Belt Mistracking

Section 1: Rule Zero and Set-Up *(continued)*

1.6

- Check to make sure adequate tension has been applied on all drive and gravity take up pulleys. If a belt is under or over tensioned this may cause belt misalignment.

If you are unsure as to whether the tension of your conveyor is correct, please consult your original conveyor specs or conveyor supplier for more detail on belt tension.

1.7

- Pulley take up adjustment devices such as the one below in figure 1.7, should never be used to track the conveyor belt. These take up devices are there only to provide adequate tension on the belt and should be set-up square to the direction of belt travel.

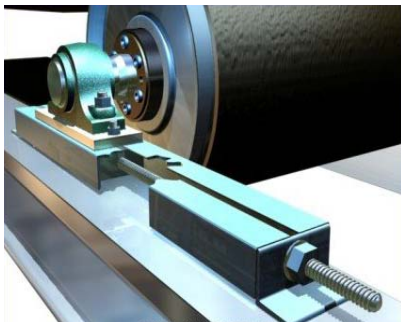
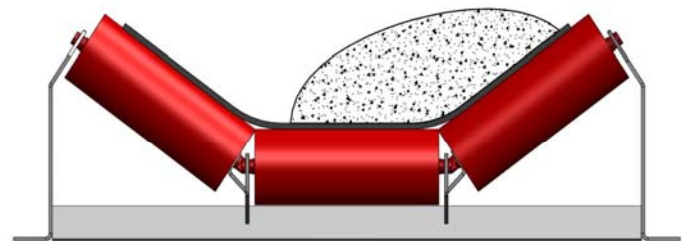

Figure 1.7 (above)

1.8

- Asymmetric loading such as the one below in figure 1.8, of the transfer point is one of the most difficult causes of belt tracking issues to address, and causes the most problems. Belt tracking devices are a must in this case as dry and wet running will not be cared for by manual idler adjustment.



THEN

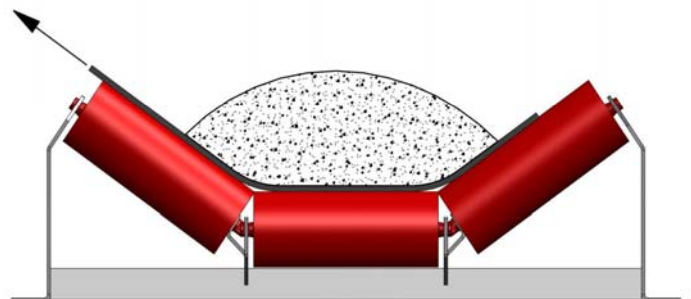

Figure 1.8 (above)



How to Prevent Conveyor Belt Mistracking

Section 2: Belt Tracker Install / Set-Up

2.1

- When installing any belt tracking idler, it is important to refer to the specific manufacturers installation documents. There are many different types of belt trackers available which all rely on different setups and individual components.

2.2

- When using a conventional belt tracking idler like the one shown in figure 2.2, the correct orientation and engagement is vital in the performance of the belt tracker.

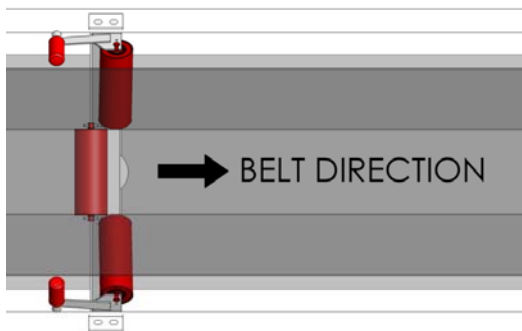

Figure 2.2 (above)

- When installed on low to moderate tensioned conveyor belts, the tracking idlers should be installed between 12mm and 19mm above the standard idler profile. This will enable proper traction between the pivoted rollers and conveyor belt.
- For high tension conveyor belt tracking idler installations, please consult your equipment supplier for more defined/calculated engagement figures.

2.3

- Depending on the type of belt tracker you are installing, the total amount required will differ. Most tracking devices however will be effective between a range of 25-50 metres.

2.4

- NO belt tracking idler should be installed closer than 3.5 x (belt width) away from any conveyor pulley. This includes all bend pulleys and other pulleys with low angle of wraps.

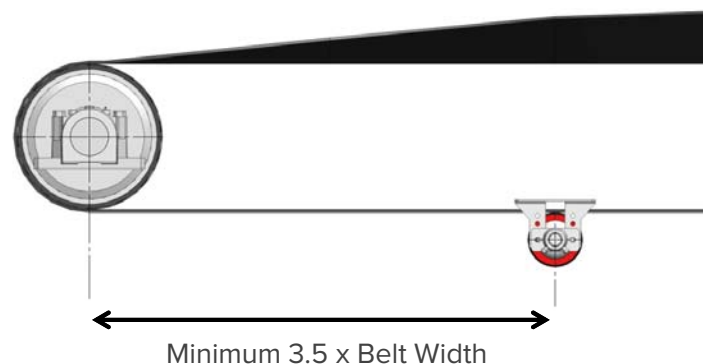

How to Prevent Conveyor Belt Mistracking

Section 2: Belt Tracker Install / Set-Up *(continued)*

2.5

- Figure 2.5 below shows which direction the conveyor belt will track towards once rollers have been shifted from square to stringers. The angle has been exaggerated for demonstration and should not exceed 2 degrees in the field.

* Note: This technique cannot be used on bi-directional conveyors.

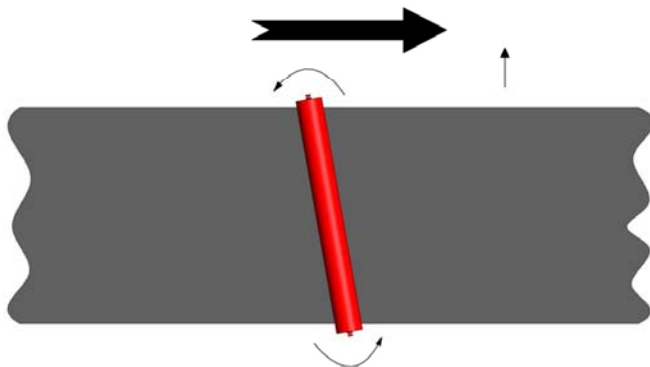

Figure 2.5 (above)

2.6

- A group of idlers in the effected tracking zone should be adjusted rather than one only being adjusted too much. This not only will be more effective but also will reduce the wear and tear of roller shell and conveyor belt covers.

2.7

- In figure 2.7 another technique is used to help aid belt tracking. This is unbiased to a particular side.

* Note: This technique cannot be used on bi-directional conveyors.

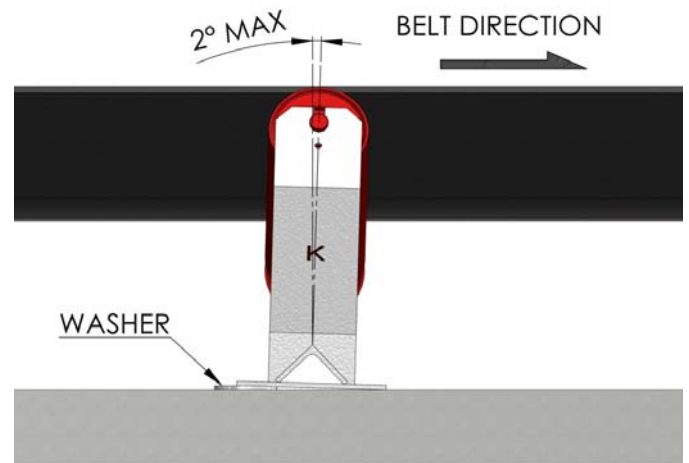

Figure 2.7 (above)



How to Prevent Conveyor Belt Mistracking

Section 3: Belt/Splice Condition and Specification

3.1

- If a conveyor belt mistracks only in one or more specific areas of the belt itself, then it may be necessary for you to check the quality of the splice or fastener.
- The above issue may also be caused by a defect and or damage within the conveyor belt itself. One of these defects that have been known to affect belt tracking is commonly referred to as “Belt Camber”. See figure 3.1 below.

*Example: If the inward camber on a 10m long piece of conveyor belt is 60mm then this equates to 0.6%, which would mean it is not in spec as per the Australian Standard. *Please note, if you have not requested the belt to be supplied as per a particular standard then the above does not apply.*

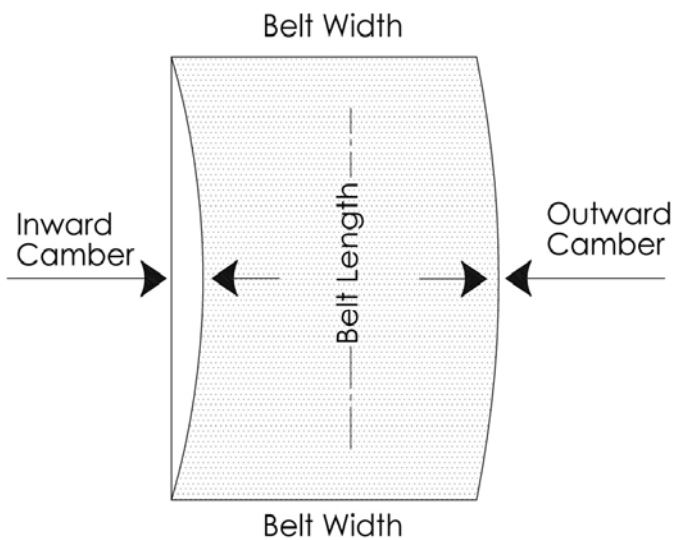

Figure 3.1 (above)

- The maximum allowable belt camber as per the Australian Standard 1332 is 0.5% of the test piece length.



How to Prevent Conveyor Belt Mistracking

Section 4: Belt Tracking Components Available

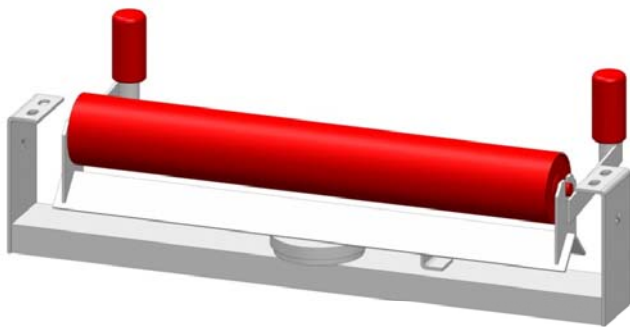

K-Return Tracking Idler

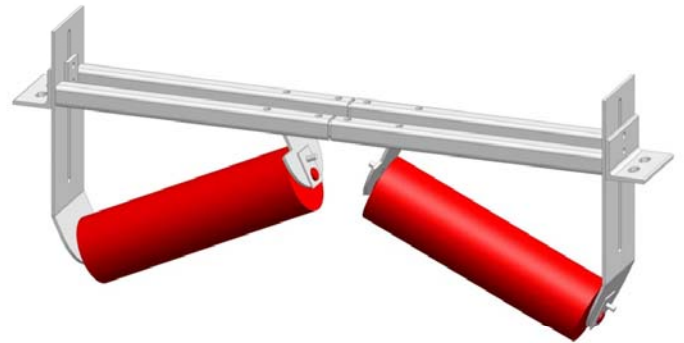

K-Trainer Belt Alignment Idler

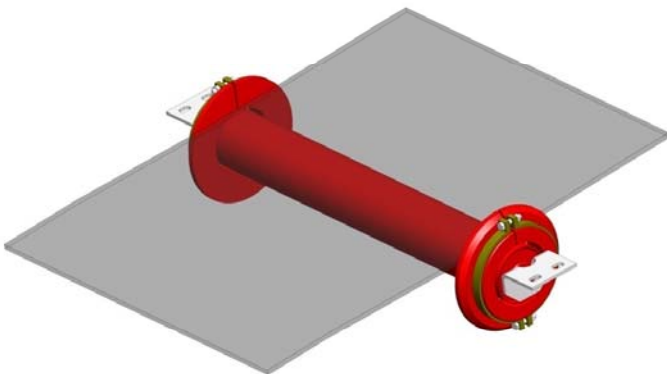

MTD Disc Tracker



MTD Disc Tracker (loose)



How to Prevent Conveyor Belt Mistracking

Section 4: Belt Tracking Components Available *(continued)*

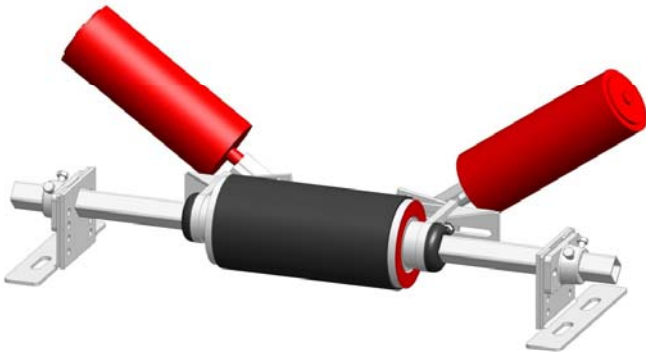

Tru-Trac® Trough Trainer Conveyor Belt Tracking System



Tru-Trac® Flat Return Conveyor Belt Tracking System

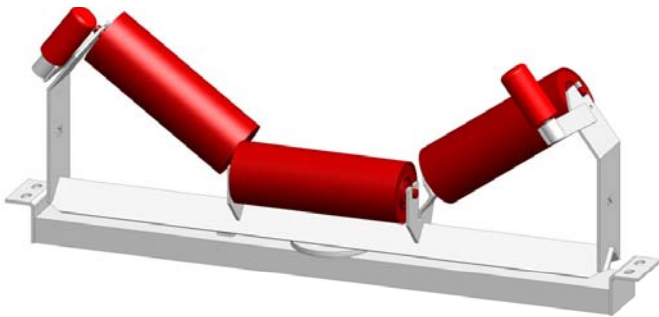

K-Self Aligning Idlers

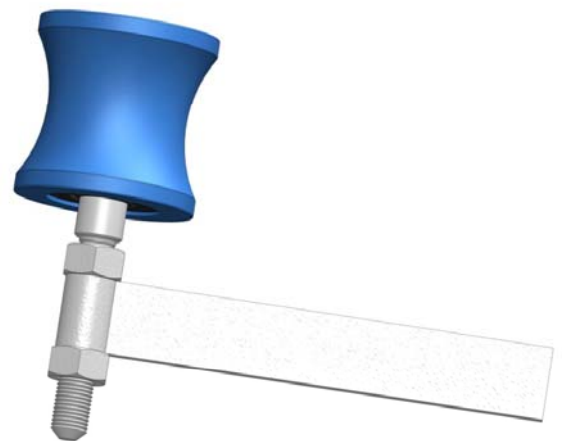

K-HD Polyurethane Guide Roller

